

The Power of Hydraulics

Moil Point

Narrow Chisel

3" Chisel



STANDARD

SHANK SIZE	LENGTH	PART #	WEIGHT	PART #	WEIGHT	PART #	WEIGHT
1" x 4 1/4"	14"	A21014	4 1/2	A22014	4 1/2	A23014	5
	18"	A21018	5 1/2	A22018	5 1/2	A23018	6
	24"	A21024	6 3/4	A22024	6 3/4	A23024	7 1/2
	36"	A21036	8 3/4	A22036	8 3/4	A23024	10 1/2
	48"	A21048	12 1/2	A22048	12 1/2	A23048	13 1/2
	60"	A21060	14 1/2	A22060	14 1/2	A23060	16
1 1/8" x 6"	14"	A31014	6	A32014	6	A33014	6 3/4
	18"	A31018	7 1/4	A32018	7 1/4	A33018	8
	24"	A31024	9	A32024	9	A33024	10 1/4
	36"	A31036	12 1/2	A32036	12 1/2	A33036	14 1/4
	48"	A31048	16	A32048	16	A33048	17 1/2
	60"	A31060	18 1/2	A32060	18 1/2	A33060	20
72"	A31072	23	A32072	23	A33072	20 3/4	

HI-DUTY

SHANK SIZE	LENGTH	PART #	WEIGHT	PART #	WEIGHT	PART #	WEIGHT
1" x 4 1/4"	14"	A24014	4 3/4	A25014	4 3/4	A26014	5 1/2
	18"	A24018	6	A25018	6	A26018	6 1/2
	24"	A24024	8 1/4	A25024	8 1/4	A26024	8
1 1/8" x 6"	14"	A34014	6 1/2	A35014	6 1/2	A36014	7 1/4
	18"	A34018	7 3/4	A35018	7 3/4	A36018	8 1/2
	24"	A34024	10	A35024	10	A36024	10 3/4



623 W. Seventh Street
 Sioux City, Iowa 51103 U.S.A.
 Nationwide (800) 382-3599
 Telephone (712) 279-8093
 FAX Number (712) 279-8070
 E-Mail: stanley-sales@steffeninc.com
 Website: www.steffeninc.com



The Power of Hydraulics

Clay Spade

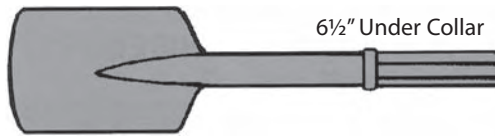

Shank Size	4 1/2" Blade	5 1/2" Blade	Weight
1 1/8" x 6"	B30200	B30300	10

Asphalt Cutter

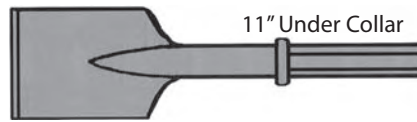

Shank Size	Blade	Part #	Weight
1" x 4 1/4"	5" x 6"	B20500	6 1/2
1 1/8" x 6"	5" x 6"	B30500	8 1/2

Digging Chisel



Shank Size	Length U.C.	Blade	Part #	Weight
1" x 4 1/4"	17 1/4"	3" x 10"	B20600	7 1/2
1 1/8" x 6"	16 1/2"	3" x 12"	B30600	8 3/4

Tarmac Cutter

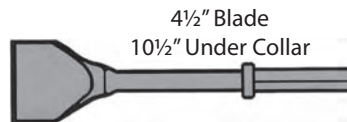

Shank Size	Part #	Weight
1" x 4 1/4"	B20035	7 1/4
1 1/8" x 6"	B30035	7 3/4

Brick Removing Tool

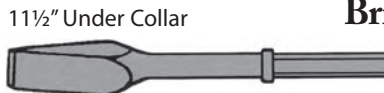

Shank Size	Blade	Part #	Weight
1" x 4 1/4"	2 1/8" x 5"	B20900	6 1/2
1 1/8" x 6"	2 1/8" x 5"	B30900	7

Bushing Tool



Shank Size	Length U.C.	Part #	Weight
1" x 4 1/4"	9"	B21000	5 1/4
1 1/8" x 6"	9"	B31000	7

Frost Wedge



Shank Size	Blade	Part #	Weight
1" x 4 1/4"	1 7/8" x 12"	B20700	9
1 1/8" x 6"	2" x 12"	B30700	10 1/2

Keen Kuts

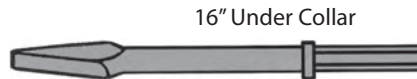

Shank Size	Part #	Weight
1 1/8" x 6"	A90008	7

Asphalt Wedge



Shank Size	Blade	Part #	Weight
1" x 4 1/4"	3" x 7"	B21000	6
1 1/8" x 6"	3" x 7"	B31000	7 1/4

Concrete Buster

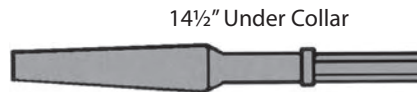

Shank Size	Part #	Weight
1" x 4 1/4"	B20800	10
1 1/8" x 6"	B30800	11



623 W. Seventh Street
 Sioux City, Iowa 51103 U.S.A.
 Nationwide (800) 382-3599
 Telephone (712) 279-8093
 FAX Number (712) 279-8070
 E-Mail: stanley-sales@steffeninc.com
 Website: www.steffeninc.com



The Power of Hydraulics



Detachable Shank

9" Under Collar

Shank Size	Part #	Weight
1" x 4 1/4"	B21200	5 1/4
1 1/8" x 6"	B31200	6 3/4



Sheathing Driver Shoe

Inside Diameter	Part #	Weight
2"	B91502	14 1/2
3"	B91503	16 1/2

Shoes Only for use with Wood Sheathing Only



Dirt Tampers, Round & Square

Outer Diameter	Part #	Weight
7" Round	B91607	14 1/2
6" Square	B91606	12 3/4
8" Square	B91608	19 1/2

Pads Only

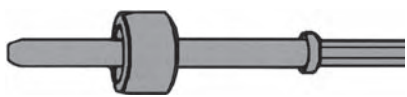

Pipe Driver

Larger Drivers are two pieces sold as a set.

Shank Size	Specify Size Pipe To Be Driven	Part #	Weight
1" x 4 1/4"	1/4" Pipe	B21859	6
	1" to 2" Pipe	B21861	6
1 1/8" x 6"	1" to 2" Pipe	B31861	14
	1 1/4" to 2" Pipe	B31863	14

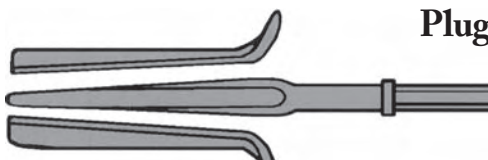

Plug & Feathers

Specify for 1 1/2" or 2" Hole

Shank Size	Hole Size	Unit	Part #	Weight
1" x 4 1/4"	1 1/2"	Shank	B22000	5 1/4
		Feathers	B92200	5
1 1/8" x 6"	1 1/2"	Shank	B32000	9 1/4
		Feathers	B92200	5
		Shank	B32100	9 3/4
	2"	Feathers	B92300	5

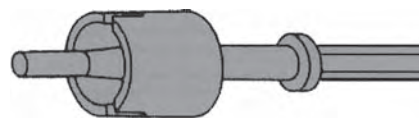

Sign Post Driver

16 1/4" Under Collar
Two Pieces Sold as a Set

Shank Size	Part #	Weight
1 1/8" x 6"	B34006	8 3/4



Railroad Spike Driver

Shank Size	Part #	Weight
1" x 4 1/4"	B41851	4 1/6
1 1/8" x 6"	B41852	6



Pin Driver

Specify size rod or pipe to be driven
1 1/8" x 6"

Shank Size	Pin Size	Number	Weight	Number	Weight
1" x 4 1/4"	5/8"	B21983	5	B31983	6
	3/4"	B21985	5	B31985	6 3/4"
	7/8"	B21987	5	B31987	6 1/2"
	1"	B21989	5	B31989	6 1/2"
	1 1/4"	B21991	4 1/2	B31991	6"
	1 1/2"	B21993	7 1/2	B31993	8 1/2"
	1 3/4"	B21995	7 1/2	B31995	8 1/4"
	2"	B21997	7	B31997	8"
	2 1/2"	B21999	7	B31999	8"

*2 piece set



Ground Rod Driver

3" Hole Depth

Shank Size	Rod Size	Socket Size	Part #	Weight
1" x 4 1/4"	5/8"	1 1/8"	B22783	5
	3/4"	1 3/8"	B22785	4 3/4
	7/8"	1 5/8"	B22787	4 1/2
	1"	1 7/8"	B22789	4 1/2
1 1/8" x 6"	5/8"	1 1/8"	B32783	6 1/2
	3/4"	1 3/8"	B32785	6 1/2
	7/8"	1 5/8"	B32787	6 1/4
	1"	1 7/8"	B32789	6 1/4



623 W. Seventh Street
Sioux City, Iowa 51103 U.S.A.
Nationwide (800) 382-3599
Telephone (712) 279-8093
FAX Number (712) 279-8070
E-Mail: stanley-sales@steffeninc.com
Website: www.steffeninc.com

